

**OWNER'S MANUAL**  
**Add-a-Motor**  
**Universal Window Covering Motor**  
 Traverse Drapery, Sliding Panels and Vertical Blinds, or rotate Vertical Blinds.  
 X-10 and Timer Compatible.

Please Read All Instructions Before Using.  
 Save For Future Reference.  
 US Patent 4958112  
 Manufactured by Add-a-Motor, Inc.

**INDEX**

Product Uses	1
How Product Works	1
General Tips and X-10 Safety	1
Installation Steps	2 & 3
Important Tip	3
When Adjustment is Needed	3
Remote Control	3
Timer Control	4
Manual Control	4
Trouble Shooting	4
Vacation Checklist	4
X-10 Home Automation	4
Warranty and Customer Service	4
Repair	4

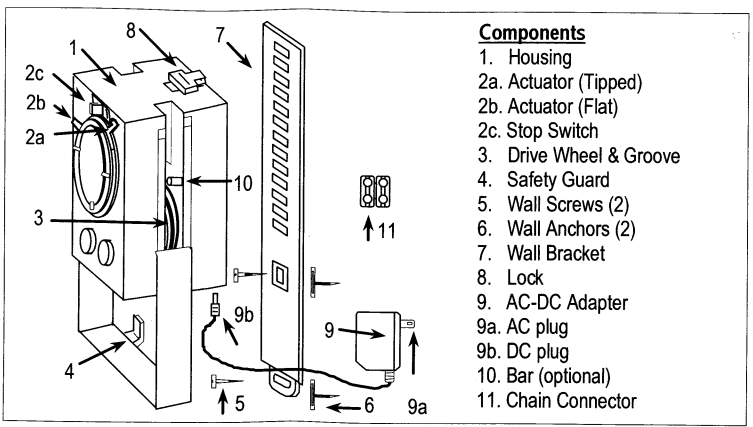

- Components**
1. Housing
  - 2a. Actuator (Tipped)
  - 2b. Actuator (Flat)
  - 2c. Stop Switch
  3. Drive Wheel & Groove
  4. Safety Guard
  5. Wall Screws (2)
  6. Wall Anchors (2)
  7. Wall Bracket
  8. Lock
  9. AC-DC Adapter
  - 9a. AC plug
  - 9b. DC plug
  10. Bar (optional)
  11. Chain Connector

Thank you for purchasing this Add-a-Motor product. We sincerely hope that you enjoy years of convenience and reliable service.

**PRODUCT USES: ADDS MOTORIZATION TO EXISTING DRAPERY AND VERTICAL BLINDS.**

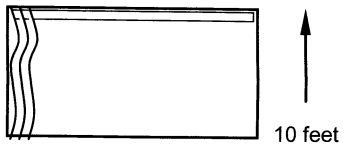

← OR →  
 Traverse 1-way, either direction.  
 Max: 8-ft. sliding-carrier track.  
 Max: 10-ft. wheel-carrier track.  
 Max: 35 pounds fabric weight.

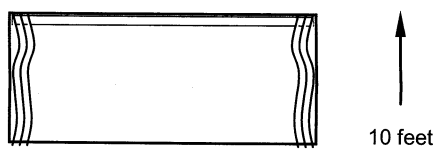

↔  
 Traverse center-open.  
 Max: 10-ft. sliding-carrier track.  
 Max: 12-ft. wheel-carrier track.  
 Max: 35 pounds fabric weight.

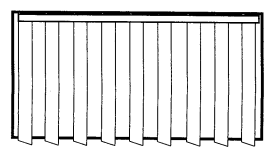

↶ ↔  
 Rotate or Traverse vertical blinds.  
 Rotate + Traverse requires 2 motors.

**HOW PRODUCT WORKS:**

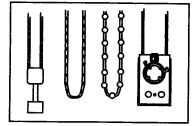

Motor replaces tension device attached to a continuous loop cord or chain.

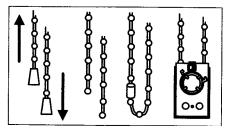

Some 2-piece cords & chains are actually a cut continuous loop. To identify this type, pull DOWN on 1-side. If opposite side travels UP, it is a cut loop. This type can be rejoined and motorized.

**NOT APPROVED FOR SHADES THAT GO UP & DOWN.  
 NOT APPROVED FOR DECORATIVE DRAPERY RODS.**

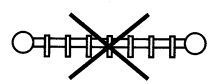
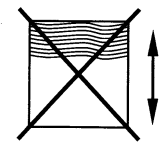

**EASY CUSTOMER INSTALLATION, USE, AND CARE.**

This product was tested before shipment and is defect free. In this booklet we have highlighted ways for you to gain product knowledge and enjoy years of convenience and reliable product service. Please follow this advice.



1. Comply with product labels and tags.
2. Before starting installation, read this entire booklet. Call us toll-free 1-888-233-6686 if you have questions.
3. After installation, a problem exists if you notice a change in the closed stop position. Correct promptly by following Step 7 page 3. Never permit motor to run after window covering reaches a travel limit. Motor gears and drive axle have an engineered stress limit and will permanently disconnect to prevent damage to your window covering. In this event, motor repair is required. Also, AC-DC Adapter fuse can open requiring replacement. These situations are not covered by warranty. Refer to Repair section on page 4.

**WARNING** X-10 users: ONLY use an Appliance Module for controlling this product. Lamp Module will damage AC-DC Adapter.

**GENERAL SAFETY: Symbols and notices are for your protection.**

Indoor use only. Do not use in presence of medical oxygen, flammable-explosive liquids or gases. Small parts pose swallow-inhalation hazard. Keep children and pets away. If any part of body, hair, clothing becomes entangled while motor operates, immediately actuate Switch 2c and unplug Adapter. Do not oil, modify or disassemble. Product may operate unexpectedly if controlled by timer or remote control out of view. Motor has Safety Guard that must be installed before use.

# Add-a-Motor Installation

Tools needed:

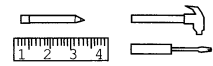

## INSTALLATION STEPS: START HERE

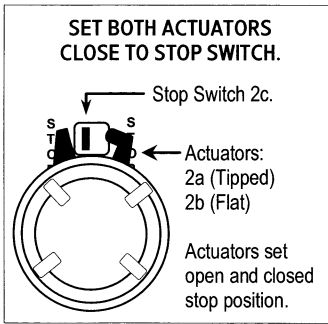

### HOW MOTOR OPERATES

- Stop Switch 2c is similar to a light switch. However, it only stops the motor. This Switch cannot start motor.
- The Stop Switch is operated automatically by Actuators 2a and 2b. Switch can also be operated manually by hand.
- When the motor runs, one Actuator moves toward the Stop Switch while the other moves away.
- When an Actuator pushes the Stop Switch from one-side to the other, the motor stops.
- After motor stops, motor will not run again until power is turned OFF for at least 2 seconds, and then back ON.
- When power is turned back ON, motor runs in opposite direction until the other Actuator moves the Stop Switch.
- Power is turned ON and OFF by remote control, timer or other available AC control switch.
- The user adjusts the Actuators closer to, or farther away from the Switch to set desired open and closed positions.
- START BY SETTING BOTH ACTUATORS** close to switch 2c. Actuators are tight - Rotate by hand.

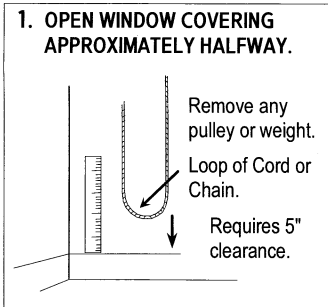

### 1. **IMPORTANT:** OPEN WINDOW COVERING APPROXIMATELY HALFWAY AND LEAVE IN THAT POSITION.

- VERIFY** that headrail is securely affixed to a strong structure.
  - REMOVE** pulley or weight attached to Cord or Chain loop.
- WARNING** Exposed cord & chain loops can be a hazard to children. Never leave unattended when children present.
- MEASURE** below loop. Required clearance is 5 inches or more. If needed, shorten cord inside track. **DO NOT** cut loop.

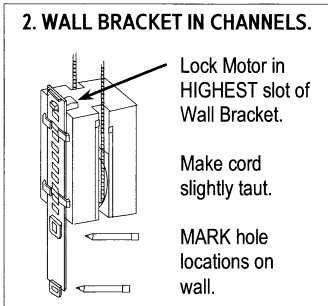

### 2. SLIDE WALL BRACKET INTO CHANNELS ON THE REAR OF THE MOTOR.

- LOCK** Motor in **highest** slot of Wall Bracket as shown.
- REMOVE** U-shape Safety Guard by sliding it off bottom of Motor.
- UNTWIST** window covering cord (chain) and open loop.
- PLACE** Drive Wheel Groove on loop.
- HOLD** against wall making cord (chain) **VERTICAL**, and **SLIGHTLY TAUT**.
- MARK** on wall the location of the 2 oval holes in Wall Bracket.
- REMOVE** Motor from cord (chain).
- SEPARATE** Wall Bracket from the Motor.

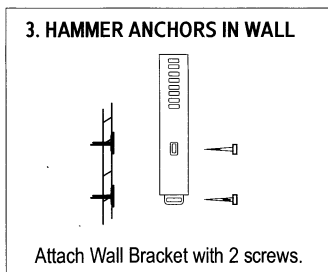

### 3. HAMMER SUPPLIED ANCHORS INTO WALL AT MARKED LOCATIONS.

(Use screws alone in wood wall. Use optional anchor for plaster wall.)

- ATTACH** Wall Bracket to Anchors with supplied screws.
- DRIVE** screws until tight. Do not over-tighten.

### THE FOLLOWING ONLY APPLIES TO CHAINS THAT ROTATE VERTICAL BLINDS.

Close blinds fully: pull cord first, then chain. Next, pull chain to rotate open to desired position. If pull length is more than 3-inches, proceed with installation. If pull is less than 3-inches, do the following. With blinds rotated to desired position, attach supplied Connector 11 (for plastic bead-chain) on chain side that traveled UP while opening. Connector **must** touch headrail. Pull chain to verify that open travel is restricted. Rotate blind closed about **halfway** and leave in this position. Set Actuators 2a and 2b **touching** Switch 2c. Proceed with installation. To avoid damage to vertical blinds: 1. When opening, **ROTATE first**. 2. When closing, **ROTATE last**.

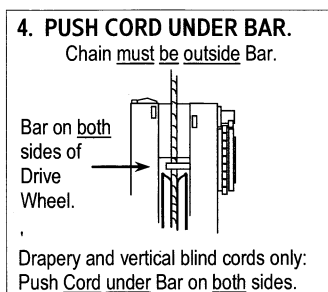

### 4. OPEN WINDOW COVERING HALFWAY. UNTWIST CORD AND OPEN LOOP.

- PLACE** Drive Wheel Groove on loop.
- PUSH** Cord under Tension-Bars on both sides of Drive Wheel.
- DO NOT** place a Chain under these Bars

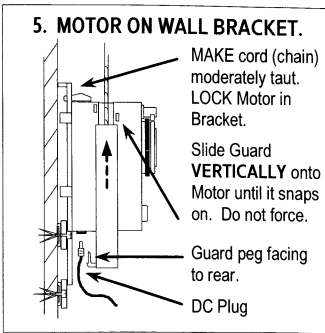

**5. SLIDE MOTOR ONTO WALL BRACKET.**

- LOWER Motor on Wall Bracket and remove any slack in cord (chain).
- MAKE cord (chain) moderately taut. LOCK Motor in nearest slot in Wall Bracket.
- SLIDE U-shape Safety Guard onto Motor VERTICALLY from underneath, Peg facing rear.
- INSERT Adapter DC output plug into receptacle at bottom of Motor.

**MOTOR WILL OPERATE IMMEDIATELY DURING STEP 6. FIRST, READ ALL INSTRUCTIONS INSIDE FOLLOWING BOX**

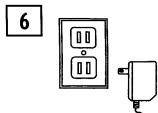

- WINDOW COVERING MUST BE APPROXIMATELY HALF OPEN.
- WINDOW COVERING CORD MODERATELY TAUT ( NOT EXCESSIVELY TAUT ).
- BOTH ACTUATORS MUST BE SET CLOSE TO STOP SWITCH 2C.

**6. PLUG ADAPTER DIRECTLY INTO A 120V AC ELECTRIC WALL OUTLET. BE READY TO UNPLUG ADAPTER.**

If window covering reaches desired position IMMEDIATELY UNPLUG Adapter. Then do the following.

- Manually move Stop Switch 2c from its present position to the opposite side. DO NOT MOVE IT BACK.
- If you move the Switch left, ← then rotate TIPPED-Actuator 2a until it touches the Switch.
- If you move the Switch right, → then rotate FLAT-Actuator 2b until it touches the Switch.

If motor stops before window covering reaches desired position, do the following.

- Measure remaining distance to desired position, divide by 3. Example: Distance = 24 inches. Divide by 3 = 8.
- Rotate "controlling" Actuator 8-clicks AWAY from the Switch. "Controlling" Actuator will be nearest the Switch.

Unplug Adapter from wall outlet. Wait 2 seconds. Plug it in again. Motor will run in opposite direction.

- Repeat above steps. Make final adjustment to the closed position. Fully closed is normal.
- Set desired open position, but NEVER 100% open. Set to stop 4 inches or more before full open.

**WARNING** Never allow motor to run after window covering is full open or closed. If motor labors, travel limit is reached, or cord is too taut. Set both Actuators to prevent overrun. Monitor/adjust periodically.

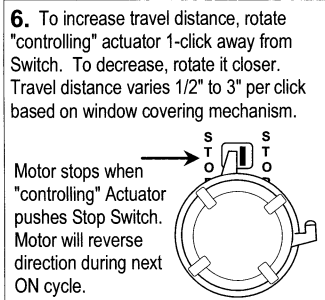

**IMPORTANT TIP**



**LISTEN . . .** If you hear a change in the motor sound, there might be a problem.

If you hear the motor make a straining sound, window covering has reached its travel limit. Immediately unplug motor and repeat Step 6. If motor is allowed to keep running, damage to gears, drive axle, Adapter, or window covering might occur.

**REQUIRED ADJUSTMENT AFTER COMPLETING STEP 6 ABOVE**



**7. IF ANY STOP POSITION CHANGES, PROMPT ADJUSTMENT IS NEEDED TO AVOID DAMAGE.**

- If window covering fails to close fully: Move Closed Position Actuator 1 or more clicks away from the Stop Switch. And move the opposite Actuator the same number of click closer to the Stop Switch to prevent over-travel in Open Position.
- If window covering over-travels: Move Actuator 1 or more clicks closer to Stop Switch.
- Check for cord slack. Lower motor one notch on wall bracket if needed. Do not force.

It is normal for window cord to stretch after motor installation. This can cause stop positions to change. Observe window covering stops. Promptly make required adjustment.

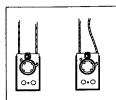

**REMOTE CONTROL**

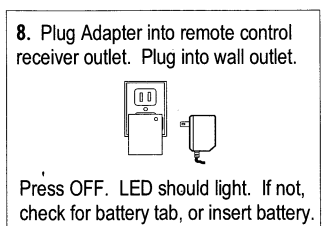

**8. PLUG ADAPTER INTO REMOTE CONTROL RECEIVER OUTLET. PLUG RECEIVER INTO WALL OUTLET.**

**WARNING** Receiver MUST have label approved for appliance use, motor, or marked HP. NEVER use Lamp Module.

- Press OFF button. LED should light. If not, check battery compartment for paper tab on terminals, or insert battery.
- Press and hold ON button until motor starts, then release button. Window covering will move to set position then stop.
- Press and hold OFF button until Motor stops. Motor will not run again unless Receiver switches OFF. Wait 2 seconds after Receiver switches OFF to allow Motor electronics to reset.
- To move window covering to opposite position, press and hold ON button until motor starts.
- If OFF button is pressed while Motor is running, Motor will stop. When ON button is pressed again, Motor will run in the original direction until set position is reached.

## TIMER CONTROL: Home security. Energy savings. Convenience.

Plug AC-DC Adapter into lamp timer switch that has a minimum of 2 On and 2 Off settings per day. **Never** use a timer that has a dimming capability (AC-DC Adapter will be damaged). **Timer label must state that it is approved for appliance use, motor load, or have the designation HP.**

Timer ON setting controls WHEN window covering is repositioned. The timer must be set to switch OFF after every ON.

**Example:** Open window covering at 8:30 AM, and close it at 7:00 PM.

1. Set Timer for current time of day (AM-PM).

2. Set Timer to switch ON at 8:30 AM. **IMPORTANT:** Set Timer to switch OFF as soon as possible thereafter. For example, OFF at 9:00 AM.

3. Set Timer to switch ON at 7:00 PM. **IMPORTANT:** Set Timer to switch OFF as soon as possible thereafter. For example, OFF at 7:30 PM.

Note: To open or close sooner than a preset time, turn Timer manual switch to ON. Motor will operate and stop at set position. To return to original open/closed schedule, leave timer ON, and allow it to go through its scheduled cycle. When the next ON occurs, the motor will ignore it. The next OFF will then reset original sequence. For energy conservation, use a timer that has a minimum of 4 ON and 4 OFF settings per day. This can open and close window covering 4 times daily.

## MANUAL CONTROL: During electrical power outage.

Unplug AC-DC Adapter. Unlock motor and raise up on wall bracket. Pull window covering cord (chain) by hand. When power is restored, repeat Step 6.

## TROUBLE SHOOTING First, check remote control battery. Press OFF button. LED should light. If not, replace battery.

**Motor does not operate. Push Switch 2c to opposite side then back. Retry.**

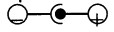
- ◆ Verify that DC plug is inserted in jack in base of Motor.
- ◆ Plug Adapter directly into wall outlet. Motor should operate immediately; otherwise outlet is controlled by switch that is Off, or Adapter is damaged.
- ◆ UL safety fuse inside AC-DC Adapter opened. Check using other UL Listed AC-DC Adapter with DC output of 9 to 12 volts, 1 amp max. **Output plug must be center positive.** 

**Open – closed sequence has reversed.**

- ◆ An electric power failure can change Timer settings. Verify AM-PM, and time of day settings. Also, verify that an OFF setting follows every ON.
- ◆ Timed event preempted. Refer to TIMER CONTROL section.

**Closed Stop Position changed.**

- Check for an obstructed or crimped headrail. Repair, or replace.
- Follow Step 7.
- Never set 100% open as a stop position.** Adjust motor to stop 4 inches or more before full-open to avoid overtravel. OK to set closed as stop position.

**Headrail squeaks: Apply dry wax to channel rails. DO NOT APPLY TO CORD.**

**Motor squeaks: Apply liquid hand soap to sides of drive wheel (do not oil).**

Apply 1-drop hand soap to edge of 3x5 card or folded paper. Slide between housing on both sides of drive wheel and wipe back and forth. **Never apply in groove.**

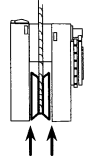

## VACATION CHECKLIST

- If remote control is used, unplug motor to prevent a spurious signal from operating.
- If timer is used, verify that it is set to switch itself OFF after every ON.
- Adjust Actuator to stop motor 10 inches or more before full open.
- Inspect and eliminate any Cord/Chain slack. Lock in Wall Bracket.

## X-10 AND HOME AUTOMATION

X-10 has become a generic name for home automation technology. Brands include X-10, IBM, Radio Shack, others. Plug Adapter into an **Appliance Module only**. Any X-10 type controller can operate motor, such as a Universal TV remote, computer, timer, etc. **CAUTION: Never use a Lamp Module.**

## LIMITED WARRANTY AND CUSTOMER SERVICE

Product is warranted against defective materials for one year from date of purchase. In event product fails to conform to this warranty, please follow procedure below.

- **Contact Customer Service toll-free 888 233-6686** (8:30 AM to 4:00 PM Arizona time, weekdays), or email to [info@add-a-motor.com](mailto:info@add-a-motor.com). Request a Return Identification Number.
- Carefully pack and seal defective item. **Ship or mail PREPAID to:** Add-a-Motor, Inc. 16044 E Star Gaze Trail, Fountain Hills, AZ 85268.
- Write your return address and Return Identification Number on outside of package. Inside package include the following:
  1. Copy of dated proof of purchase (keep the original).
  2. An explanation of the problem, plus your Return Identification Number.
  3. Your name, address, plus telephone number (**very important**).
- A return shipping charge applies for product shipped back to Hawaii, Alaska and other locations outside CONUS.

**Warranty void if AC-DC Adapter is plugged into a receiver or timer switch rated only for lamp use. Control switch label must state use approval for appliance, motor load, or have the approval designation HP.** This warranty applies only to original purchaser. Product failure caused by any reason not related to product materials is not covered. Commercial use of product is excluded. Warranty excludes damage caused by use, misuse, abuse, neglect, and acts of God. Warranty excludes battery if supplied. No employee, agent, dealer or other person is authorized to give any warranty on behalf of Add-a-Motor, Inc. If our inspection reveals that problem was caused due to materials within the limits of this warranty, Add-a-Motor will repair or replace product free of charge. Replacement unit is under warranty for the remainder of the original warranty period. **ADD-A-MOTOR MAKES NO OTHER WARRANTY OF ANY KIND. ANY EXPRESSED OR IMPLIED WARRANTY INCLUDING MERCHANTABILITY AND FITNESS FOR A PURPOSE WHICH EXCEEDS THE OBLIGATION MENTIONED IN THIS WARRANTY ARE DISCLAIMED AND EXCLUDED IN ALL RESPECTS.** The sole obligation of Add-a-Motor is to repair or replace the product at our discretion. Add-a-Motor is not liable for incidental, consequential, or any damage or injury due to use or misuse of product whether or not product is found defective for any reason.

## REPAIR

Product damage is not covered by warranty. If motor becomes damaged, you might be able to repair it yourself and save labor and return shipping cost. The following parts are snap-in, or push-on with some screwdriver assembly required. Call us toll-free 1.888.233.6686, or email us at [info@add-a-motor.com](mailto:info@add-a-motor.com) to order needed part.

**If you choose to return the motor for inspection, please call us to obtain a Return Authorization Number before you ship it. If motor is defective, it will be repaired or replaced as stated in our warranty. If damage repair is needed, our standard charge ranges from \$29.95 to \$39.95 including parts and labor.**

1. <u>Drive Axle</u>	Repair skill level - basic.	Item No. 29008	Cost \$ 9.00: add \$9.95 shipping & handling
2. <u>Gearmotor</u>	Repair skill level - basic.	Item No. 46555	Cost \$35.17: add \$9.95 shipping & handling
3. <u>AC-DC Adapter</u>	Repair skill level - none.	Item No. 78907	Cost \$24.55: add \$9.95 shipping & handling